

PERFORMANCE CURVE  
EVMG32

EVMG32

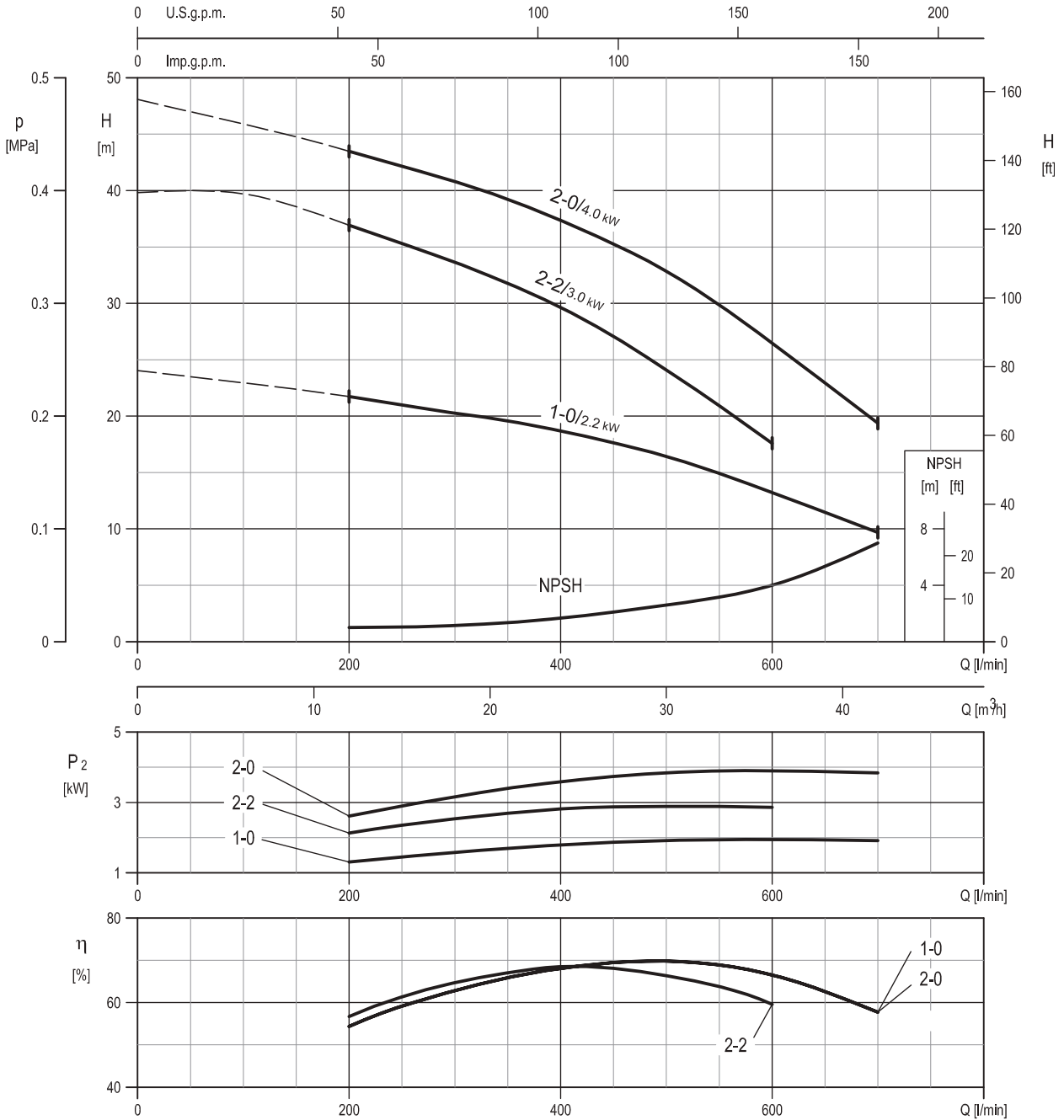

Rotation speed ≈ 2900 min<sup>-1</sup>  
Test standard: ISO 9906:2012 - Grade 3B

### PERFORMANCE CURVE EVMG32

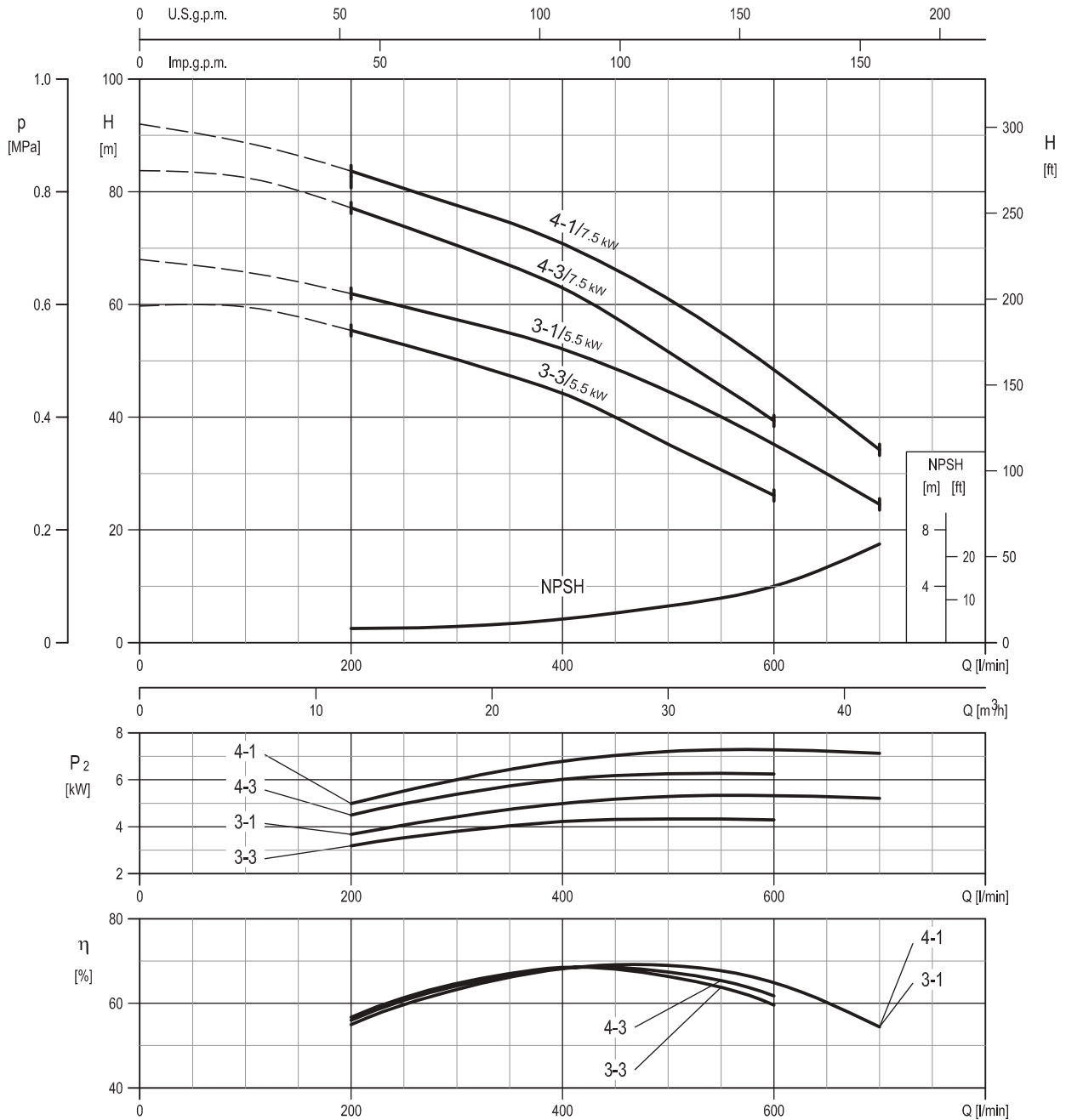

Rotation speed  $\approx 2900 \text{ min}^{-1}$   
 Test standard: ISO 9906:2012 - Grade 3B

PERFORMANCE CURVE  
EVMG32

EVMG32

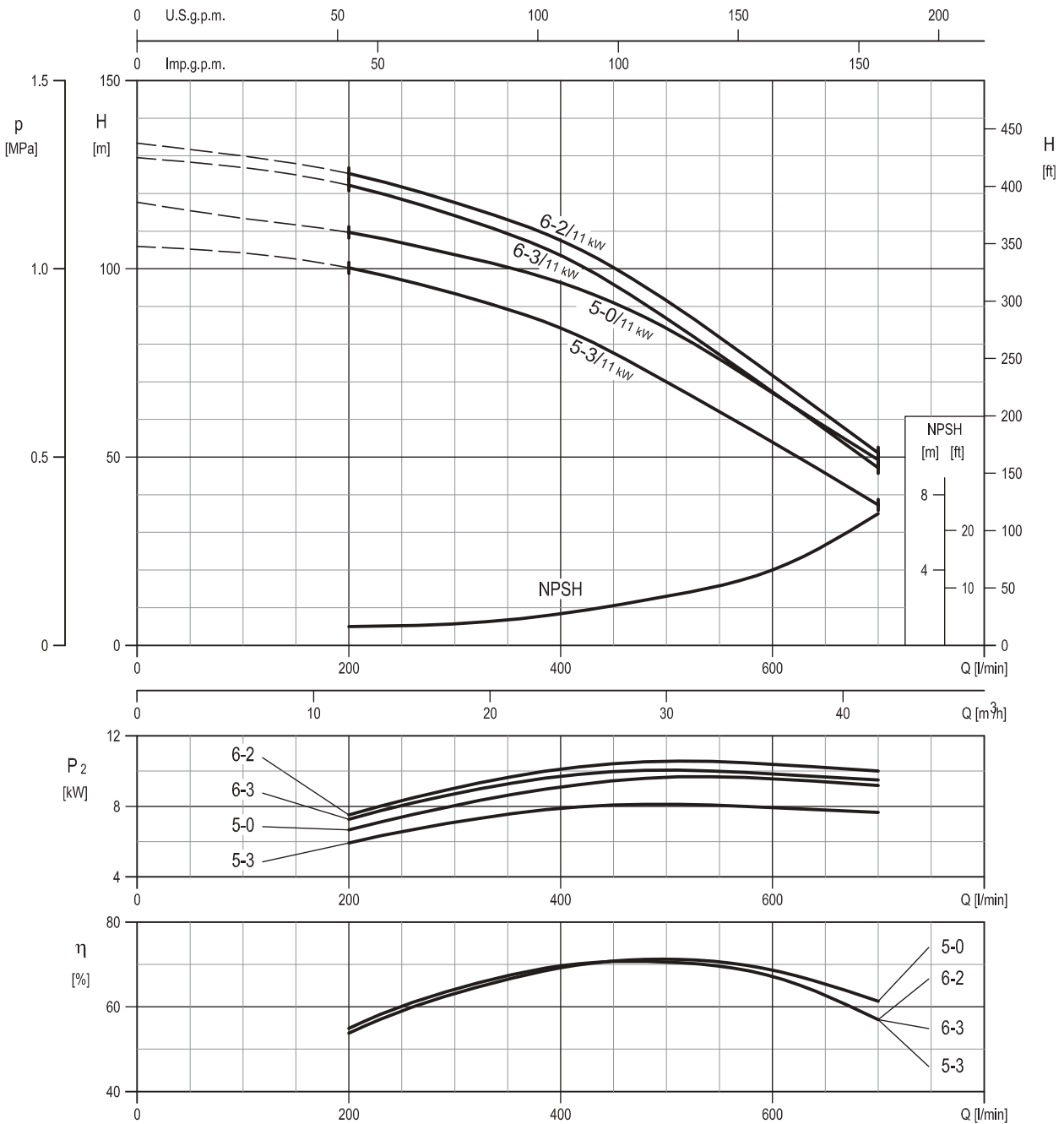

Rotation speed ≈2930 min<sup>-1</sup>  
Test standard: ISO 9906:2012 - Grade 3B

### PERFORMANCE CURVE EVMG32

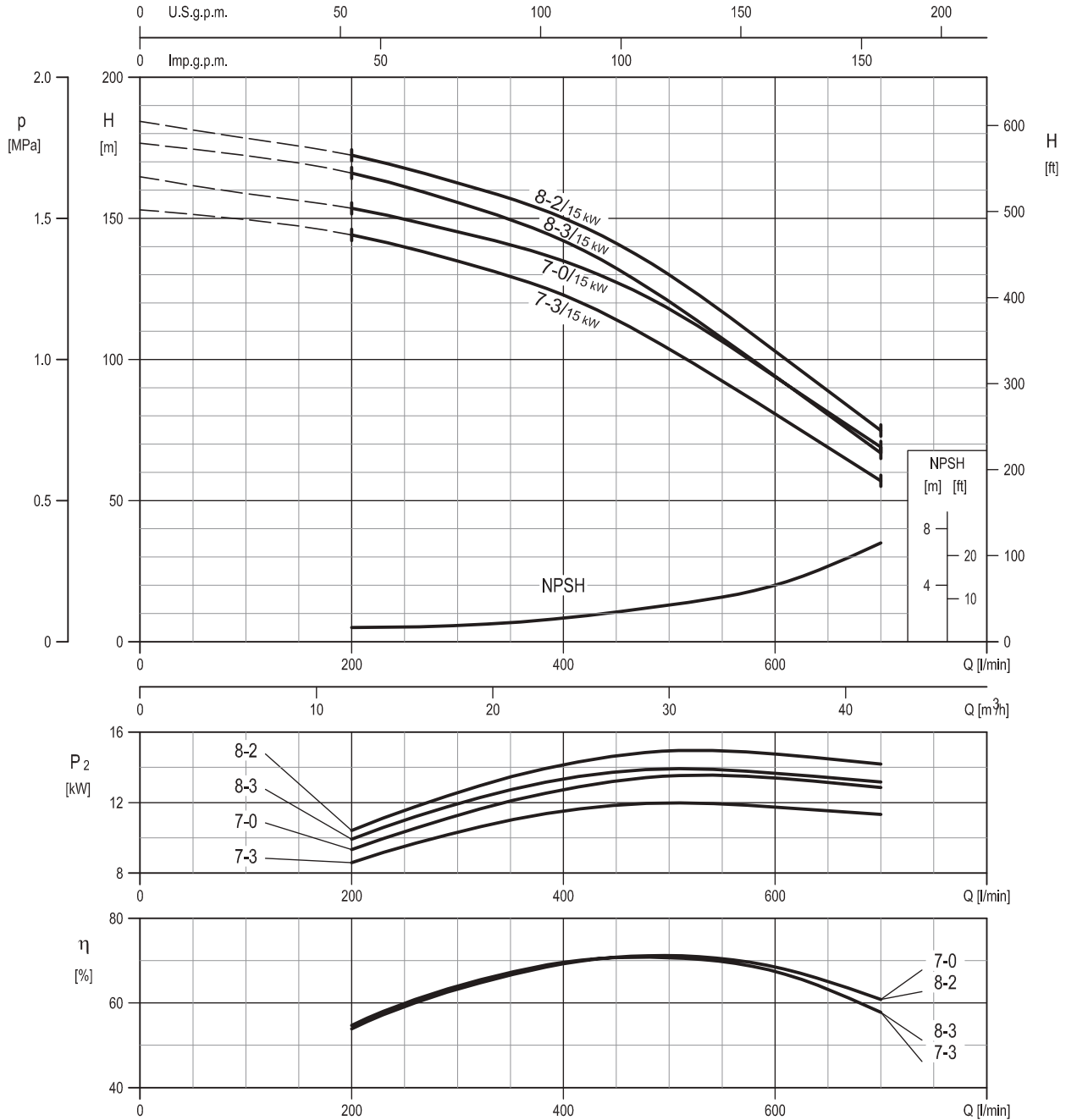

Rotation speed  $\approx 2930 \text{ min}^{-1}$   
 Test standard: ISO 9906:2012 - Grade 3B

PERFORMANCE CURVE  
EVMG32

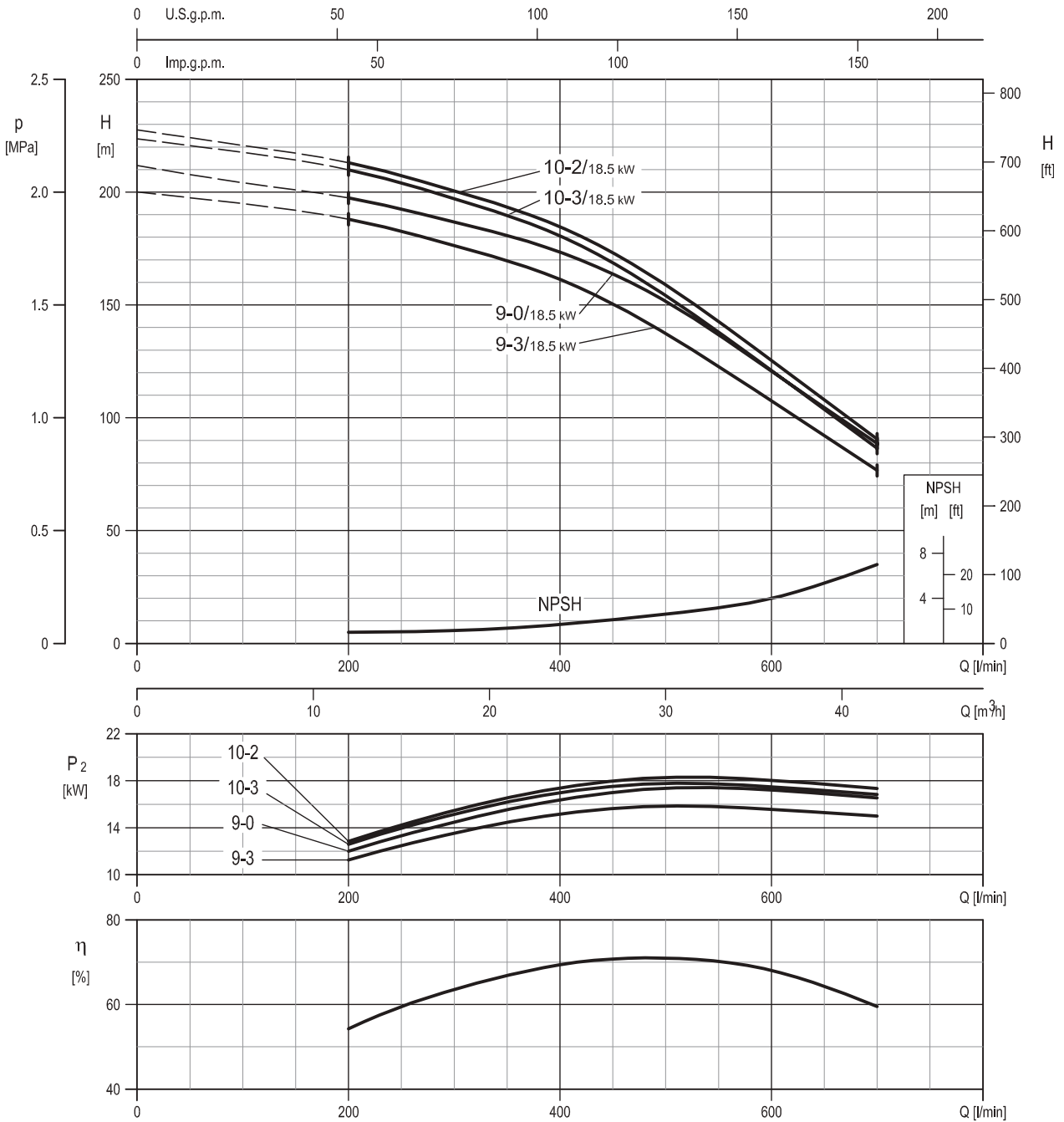

Rotation speed ≈2930 min<sup>-1</sup>  
Test standard: ISO 9906:2012 - Grade 3B

### PERFORMANCE CURVE EVMG32

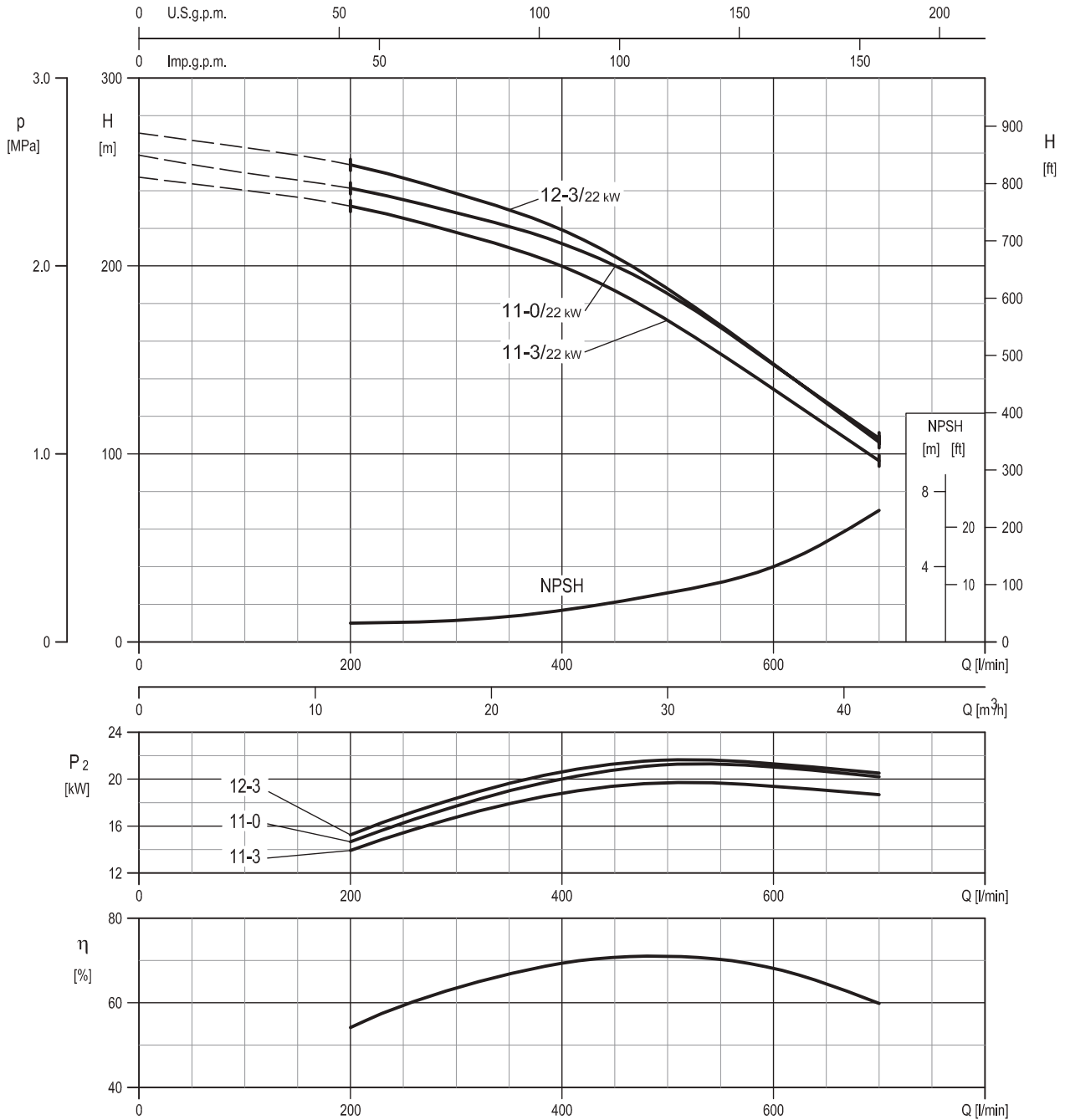

Rotation speed  $\approx 2930 \text{ min}^{-1}$   
 Test standard: ISO 9906:2012 - Grade 3B

EVMG32

PERFORMANCE CURVE  
EVMG32

EVMG32

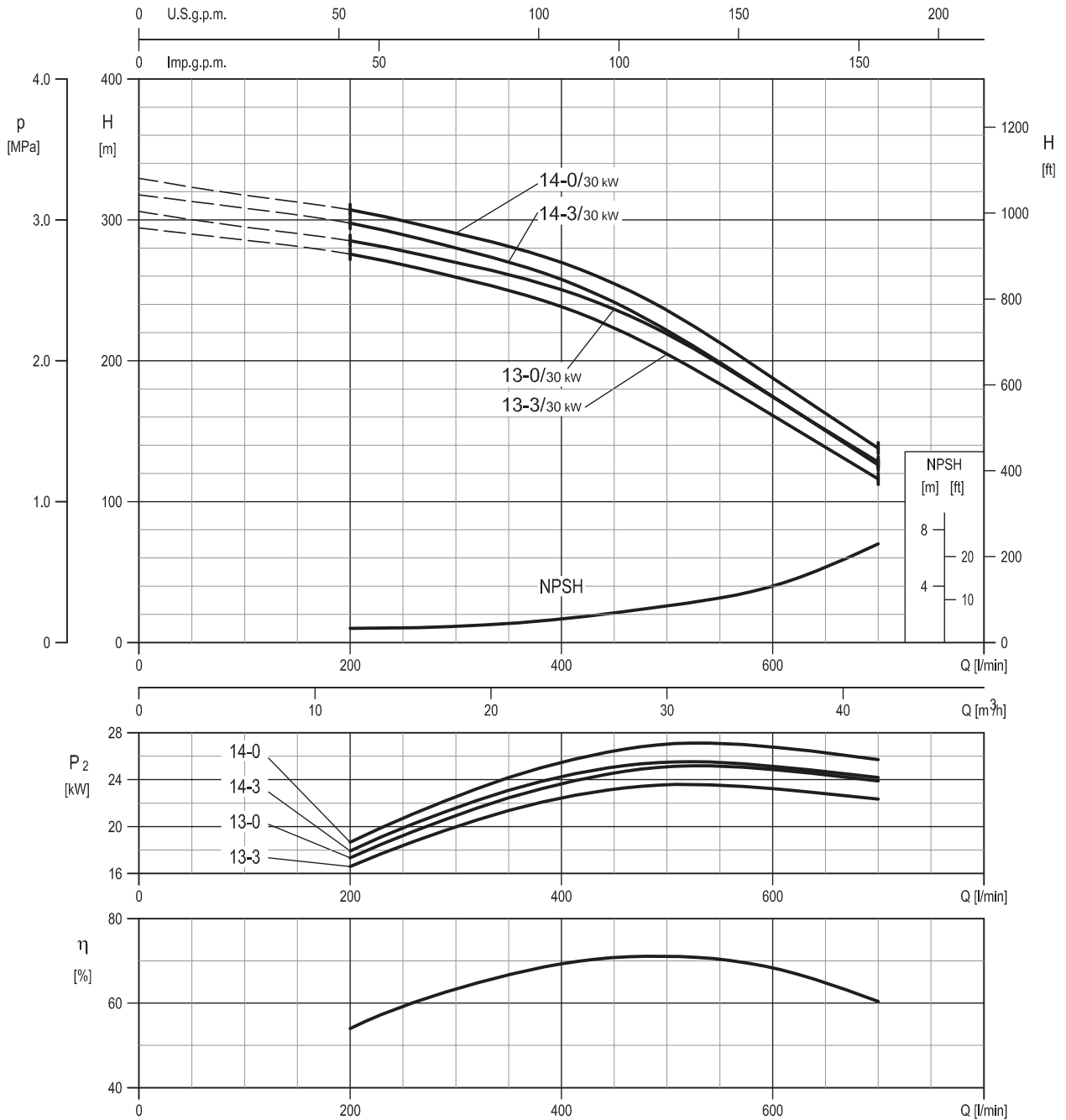

Rotation speed  $\approx 2960 \text{ min}^{-1}$   
Test standard: ISO 9906:2012 - Grade 3B

### TECHNICAL DATA EVMG32

#### Dimensional sketch

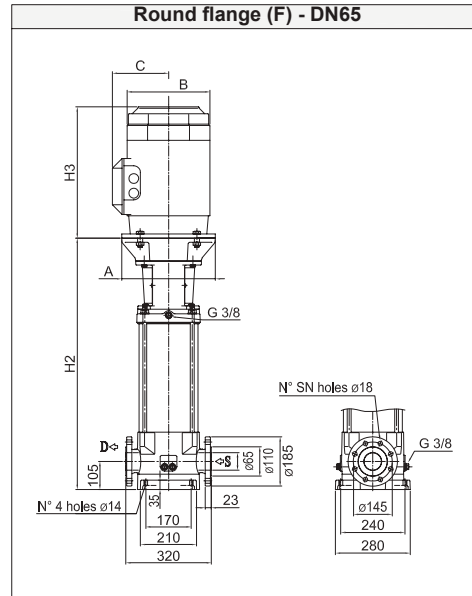

#### Dimensions [mm] and Weights [Kg]

Pump Type	Pmax [MPa]	Motor						Round flange (F)			
		kW	Size	A	3 ~			H2	SN	Weight Pump	Weight Pump + Motor
					B	C	H3				
EVMG32 1-0F5/2.2	1.6	2.2	90 L	ø140	180	148	267	493	4	56	72
EVMG32 2-2F5/3.0	1.6	3.0	100 L	ø160	196	155	306	503	4	58	80
EVMG32 2-0F5/4.0	1.6	4.0	112 M	ø160	196	155	306	503	4	58	84
EVMG32 3-3F5/5.5	1.6	5.5	132 S	ø300	225	160	328	572	4	72	111
EVMG32 3-1F5/5.5	1.6	5.5	132 S	ø300	225	160	328	572	4	72	111
EVMG32 4-3F5/7.5	1.6	7.5	132 S	ø300	225	160	350	620	4	75	116
EVMG32 4-1F5/7.5	1.6	7.5	132 S	ø300	225	160	350	620	4	75	116
EVMG32 5-3F5/11	1.6	11	160 M	ø350	248	194	476	799	4	94	156
EVMG32 5-0F5/11	1.6	11	160 M	ø350	248	194	476	799	4	94	156
EVMG32 6-3F5/11	1.6	11	160 M	ø350	248	194	476	847	4	97	159
EVMG32 6-2F5/11	1.6	11	160 M	ø350	248	194	476	847	4	97	159
EVMG32 7-3F5/15	1.6	15	160 M	ø350	317	238	498	895	4	100	189
EVMG32 7-0F5/15	1.6	15	160 M	ø350	317	238	498	895	4	100	189
EVMG32 8-3F5/15	2.5	15	160 M	ø350	317	238	498	943	8	105	194
EVMG32 8-2F5/15	2.5	15	160 M	ø350	317	238	498	943	8	105	194
EVMG32 9-3F5/18.5	2.5	18.5	160 L	ø350	317	238	542	991	8	108	212
EVMG32 9-0F5/18.5	2.5	18.5	160 L	ø350	317	238	542	991	8	108	212
EVMG32 10-3F5/18.5	2.5	18.5	160 L	ø350	317	238	542	1039	8	111	215
EVMG32 10-2F5/18.5	2.5	18.5	160 L	ø350	317	238	542	1039	8	111	215
EVMG32 11-3F5/22	2.5	22	180 M	ø350	360	268	577	1087	8	115	278
EVMG32 11-0F5/22	2.5	22	180 M	ø350	360	268	577	1087	8	115	278
EVMG32 12-3F5/22	2.5	22	180 M	ø350	360	268	577	1135	8	122	285
EVMG32 13-3F5/30	3.0	30	200 L	ø400	399	300	658	1198	8	131	359
EVMG32 13-0F5/30	3.0	30	200 L	ø400	399	300	658	1198	8	131	359
EVMG32 14-3F5/30	3.0	30	200 L	ø400	399	300	658	1246	8	134	362
EVMG32 14-0F5/30	3.0	30	200 L	ø400	399	300	658	1246	8	134	362

1.6 MPa=16 bar ; 2.5 MPa=25 bar; 3.0 MPa = 30 bar